

THE TROLLEY



PROFESSIONAL TOOLS
SW STAHL

SW STAHL
PROFESSIONAL TOOLS



YOUR WORKSHOP DNA

THE TROLLEY



MADE FOR

GREATNESS

THE TROLLEY



DESIGNED TO FINEST

DETAIL

THE TROLLEY

SW STAHL



THE TROLLEY

FIRST OF A NEW ERA!



SW STAHL IMAGEFILM

TT801
BLACK

TT802
BLUE



TT802
BLACK

TT801
BLUE

DESIGNED
IN GERMANY

CONTENTS

THE EXTERIOR	15
THE INTERIOR	33
THE ACCESSORIES	63
THE SETS	71
EVERYTHING AT A GLANCE	85
THE WARRANTY EXTENSION	99
BEHIND THE SCENES	101



SW STAHL
PROFESSIONAL TOOLS

BIRTH OF AN ICON

1

VISION

X

MEETINGS

1,024

DESIGN
HOURS

587

RENDERINGS

298

CUPS OF
COFFEE

998

SKETCHES

49

NIGHT
SHIFTS

THE TROLLEY

EXTERIOR

HIGH-TECH FROM PASSION

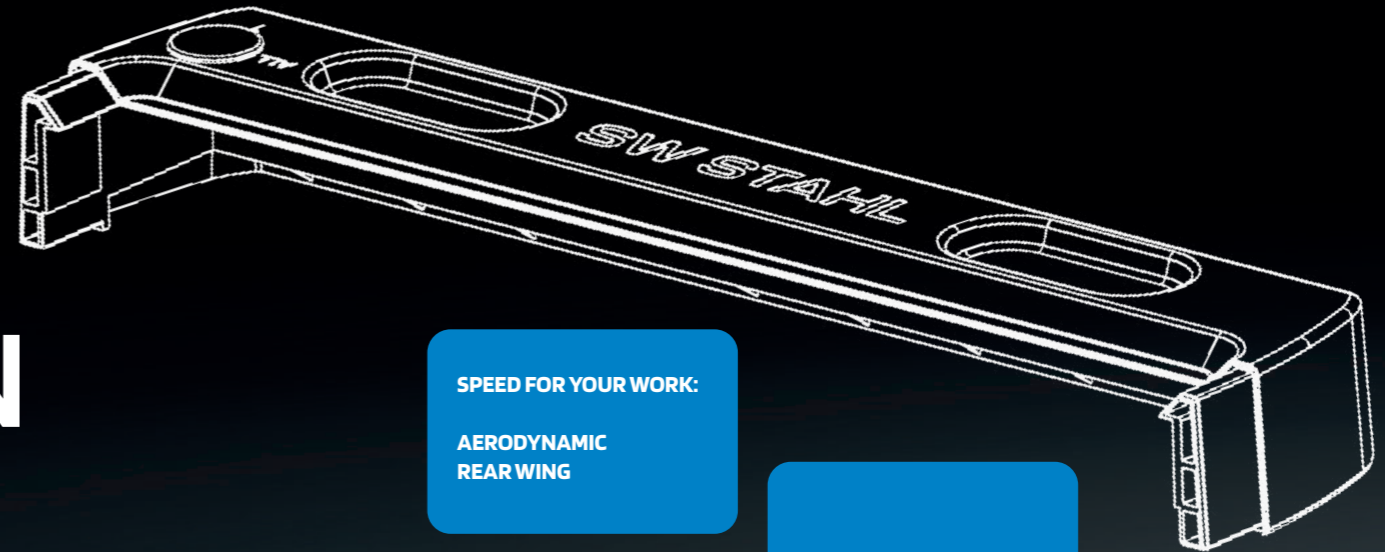

SPEED FOR YOUR WORK:

AERODYNAMIC
REAR WING

FUNCTIONAL

MAGNETIC

STAINLESS STEEL COVER
with embossed grooves and lateral seal

TWINLOCK
Locking system

MAGNETIC STORAGE COMPARTMENTS

Back-friendly **WORKING HEIGHT** of 108 cm

QUICK LOCK with automatic closing function on each drawer

PLASTIC EDGE PROTECTORS

8 DRAWERS with heavy-duty pull-out rails with up to 80 kg load

WHEELS with TPE treads for quiet rolling

CENTRALLY LOCKABLE

PERFORATED SIDE WALL for lots of accessories

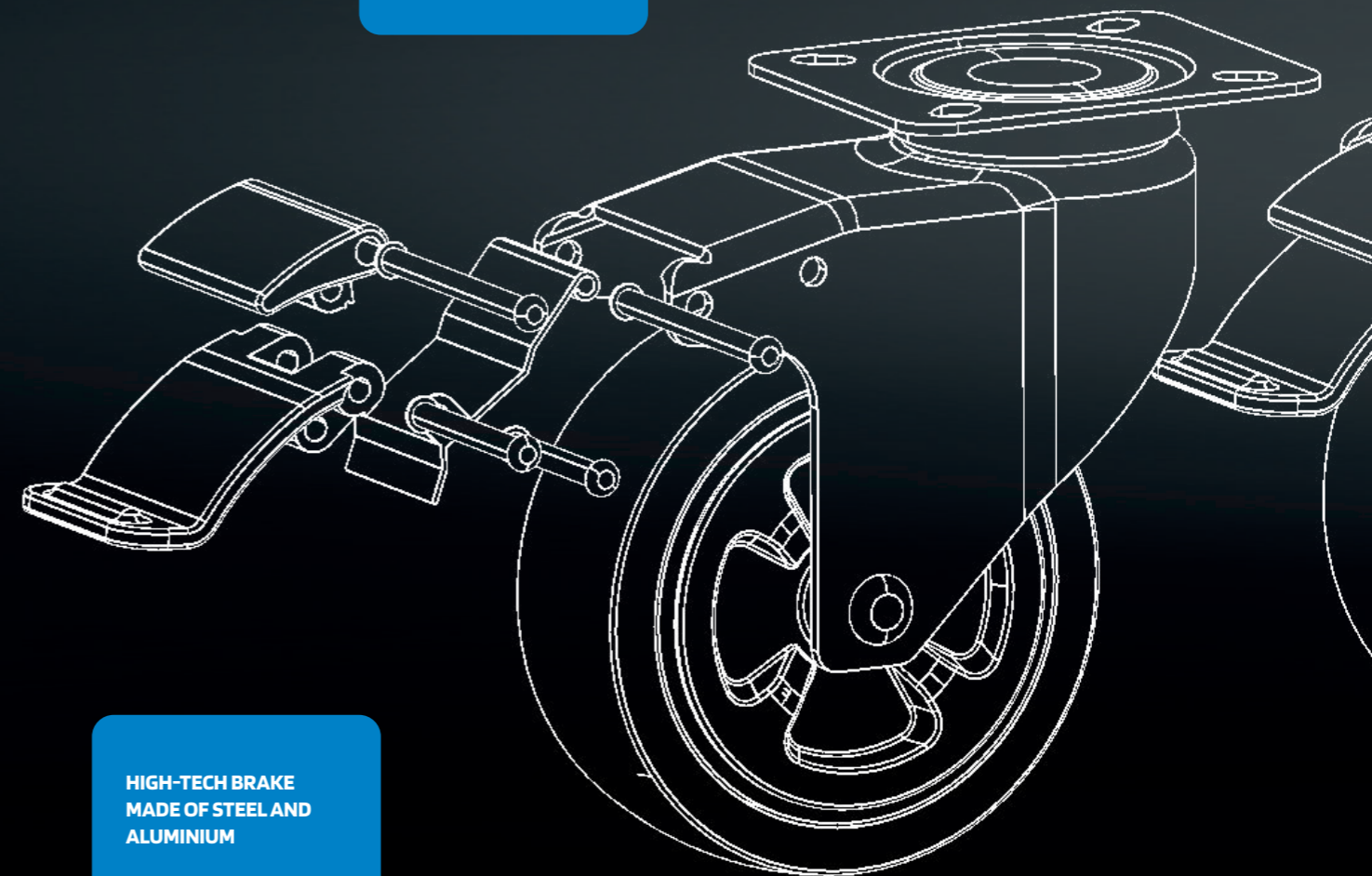
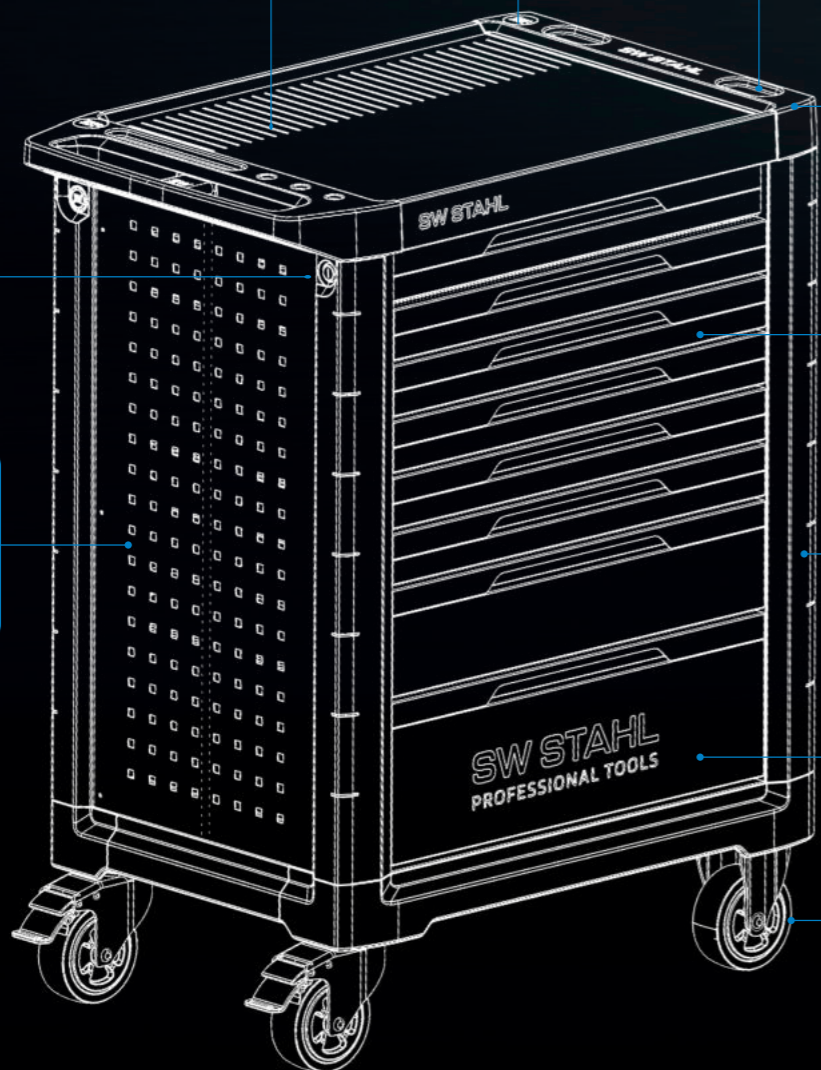

HIGH-TECH BRAKE MADE OF STEEL AND ALUMINIUM

CONSTRUCTED FOR THE RACE TRACK WORKSHOP

PERFECT TRACTION



EXTERIOR

TT801 TT802



THE TROLLEY
EXTERIOR

DESIGNED
IN GERMANY

A TRUE DREAM FIGURE!

TT801

TT802

860 mm wide
548 mm deep
1084 mm high

Max load
more than 600 kg



1050 mm wide
548 mm deep
1084 mm high

Load capacity
more than 600 kg



THE TROLLEY
EXTERIOR



TWINLOCK

WORLD FIRST BY SW STAHL!

With our unique TWINLOCK system, you have the choice and can configure your workshop trolley in the way that best suits you and your work!

THE TWINLOCK SYSTEM ALLOWS YOU TO OPEN EITHER ONE DRAWER OR ALL DRAWERS AT ONCE!

The conversion can be locked with a separate key.

IT'S YOUR CHOICE!



HOW IT WORKS

TT801 TT802

THE TROLLEY EXTERIOR

YOUR CUSTOMIZED DRAWERS



EXTRA WIDE AND STABLE DRAWER PULL-OUTS.

Our drawers run on extra wide 53 mm rails and feature a high load capacity with a high safety reserve. The rails are only loaded to approx. 50% of their maximum load and therefore have less wear and a long service life. With a load of 50 kg, we guarantee at least 25,000 openings.

PRIORITISING COMFORT.

The drawers close automatically and silently. Even if the trolley moves, the drawer remains closed - no additional locking necessary.

TT801 **TT802**

THE TROLLEY EXTERIOR



CARRIES

80 kg

BIG COVER WITH A LOT OF POWER.

Since our "strong one" is equipped with 2 pairs of pull-out rails, it manages UP TO 80 KG OF WEIGHT! This makes the bottom drawer perfect for heavy tools. Thanks to the height of the drawer, there is also enough space.



TT801 TT802

THE TROLLEY EXTERIOR



SIMPLY SEALED

YOUR TOOLS REMAINS DRY.

The seal between the stainless steel and the side plastic covers means that no liquid enters the trolley. This means that parts smeared or dripping with oil can be placed on the stainless steel cover.

TT801 TT802

THE TROLLEY
EXTERIOR

**THE
PERFECT
GRIP!**



HIGH PERFORMANCE FOR YOUR WORK:

We have redesigned the wheels and the brakes. The design of the wheels has been redesigned and the geometry of the brakes has been completely revised. A subtle colour ring in the wheels underscores the modern design. The wheels with TPE treads ensure smooth and quiet running and perfect grip.

TT801 TT802



THE TROLLEY EXTERIOR



THE SIDE CAN DO MORE!

**WORK SYSTEMATICALLY -
JUST THE WAY YOU WANT.**

The perforated side wall is ideal for attaching a wide variety of accessories. It lets you customise your workshop trolley exactly to your needs.

TT801 TT802





MAGNETIC

The magnetic pockets in the plastic covers keep their contents in place even when the trolley is moved.



KEEP AN OVERVIEW

Each insert has a storage compartment with a printed table of contents. In this way, lost tools can be quickly reordered. The storage compartment can also be used for tools.

EXTERIOR

DETAILS



NO MORE SEARCHING

No more lost keys! Every workshop trolley receives our SW STAHL key fob with the key.

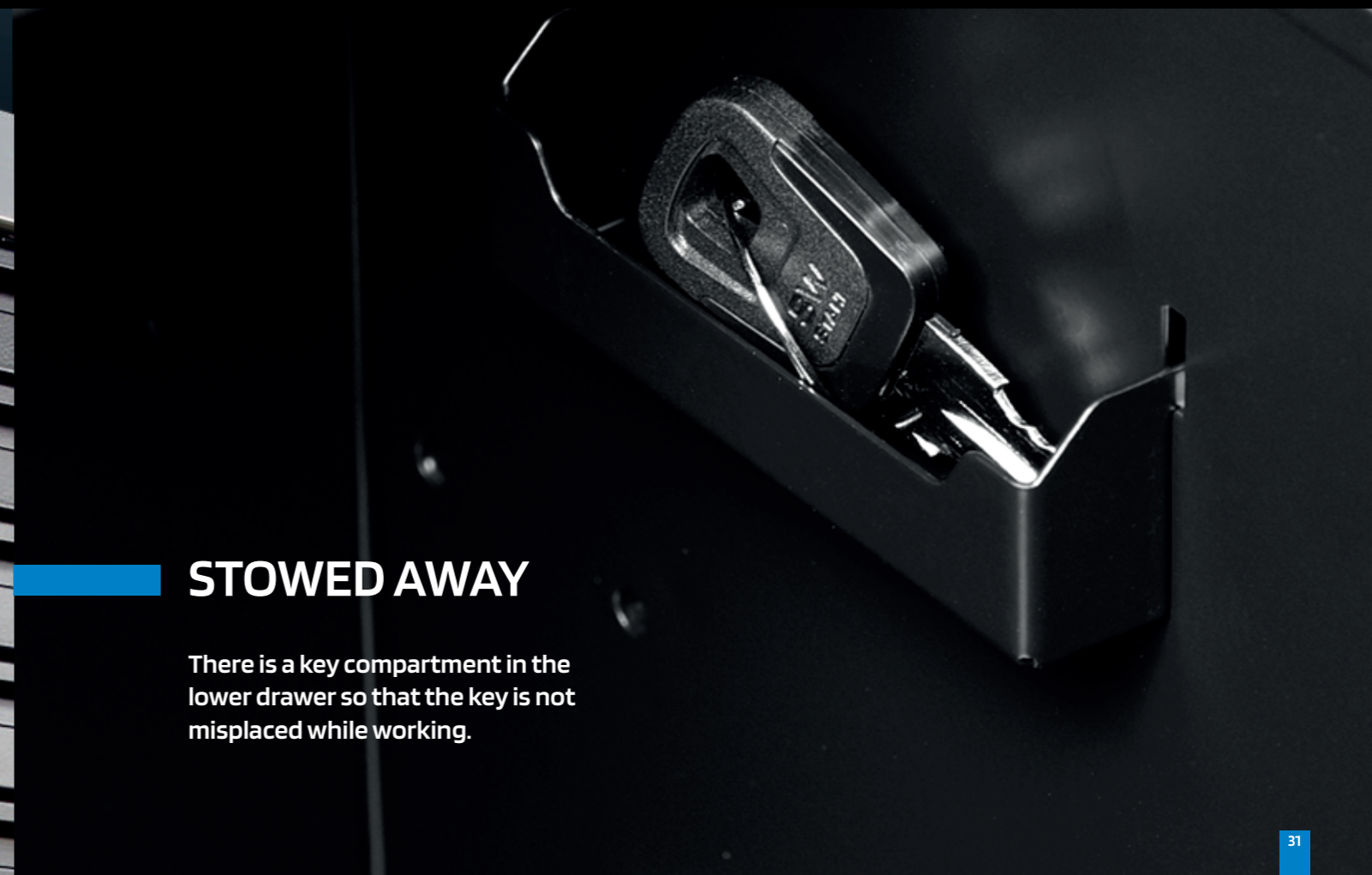

STOWED AWAY

There is a key compartment in the lower drawer so that the key is not misplaced while working.



INTERIOR

TT 801

TT 802

THE TROLLEY
INTERIOR

TT801

TT802

ONLY THE BEST
TOOLS!



THE TROLLEY INTERIOR

TT801



25

PIECE Z3011-6

WORKSHOP TROLLEY ASSORTMENT SCREWDRIVERS AND PLIERS

TOOLS

- Screwdrivers, cross, PH0 - PH3
- Screwdrivers, slot, 2,0 - 6,5 mm
- Screwdrivers, T-Profil (Torx®), T6 - T30
- Combination plier, 180 mm
- Side cutter, 180 mm
- Lever-force side-cutting plier, 200 mm
- Bent nose plier, 200 mm
- Long nose plier, 200 mm
- Water pump plier, 240 mm

INSERT

- SW-Stahl system foam insert, size 3/3
- For drawers with 570 x 400 mm
- 2-component soft foam insert
- Equipped with 25 tools
- Details see parts list

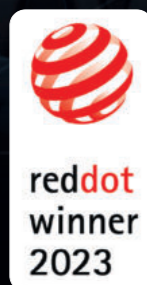
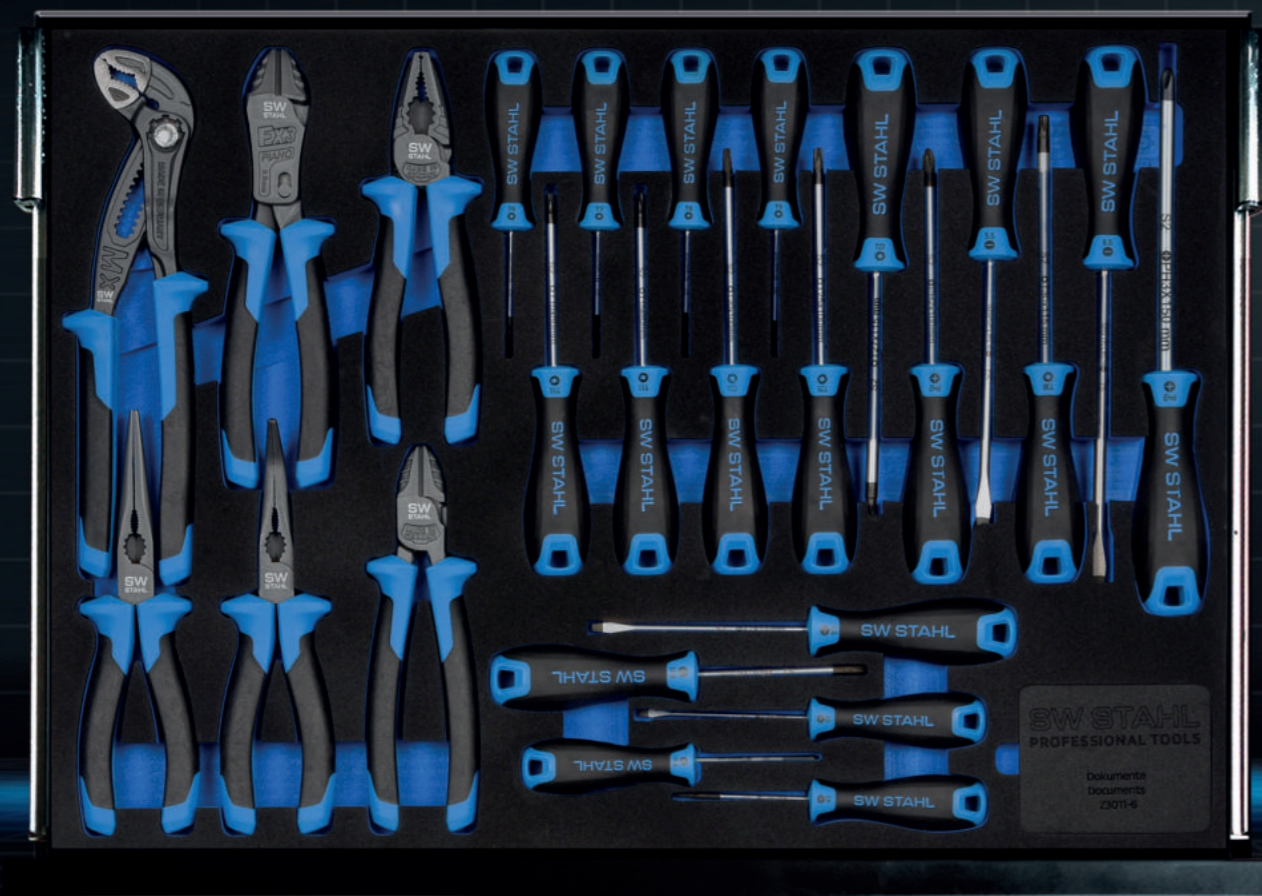

DESIGNED
IN GERMANY

THE TROLLEY INTERIOR

TT801



49

PIECE Z3011-4

WORKSHOP TROLLEY ASSORTMENT COMBINATION AND RATCHET SPANNERS

TOOLS

- Combination spanners, 6 - 27 mm
- Combination spanners, short, 10 - 19 mm
- Double-ring spanners, cranked, 6 - 22 mm
- Combination ratchet spanners, 8 - 19 mm

INSERT

- SW-Stahl system foam insert, size 3/3
- For drawers with 570 x 400 mm
- 2-component soft foam insert
- Equipped with 49 tools
- Details see parts list

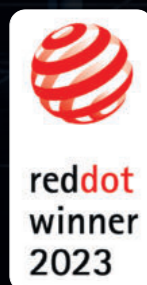

THE TROLLEY INTERIOR

TT801



167

PIECE Z3011-1

WORKSHOP TROLLEY ASSORTMENT SOCKETS AND RATCHETS 1/4" + 3/8" + 1/2"

TOOLS

- Ratchet wrench, slim design
- Sliding handles
- Extensions
- Cardan joints
- Enlargement and reduction adapters
- Socket spanners with hex and double-hex, 4 - 32 mm
- Socket spanners with E-Profil, E4 - E20
- Bit-sockets with slot, 4 - 7 mm
- Bit-sockets with cross (PH und PZ), P0 - P3
- Bit-sockets with hexagonal, 3 - 8 mm
- Bit-sockets with T-Profil (Torx®), T8 - T30
- Bit-sockets with TR-Profil (Torx® tamper resistant), T8 - T30
- Bit-sockets with TPR-Profil (TorxPLUS® Security, 5-stars), IP10 - IP30
- Bit assortment with bit adapter

INSERT

- SW-Stahl system foam insert, size 3/3
- For drawers with 570 x 400 mm
- 2-component soft foam insert
- Equipped with 167 tools
- Details see parts list

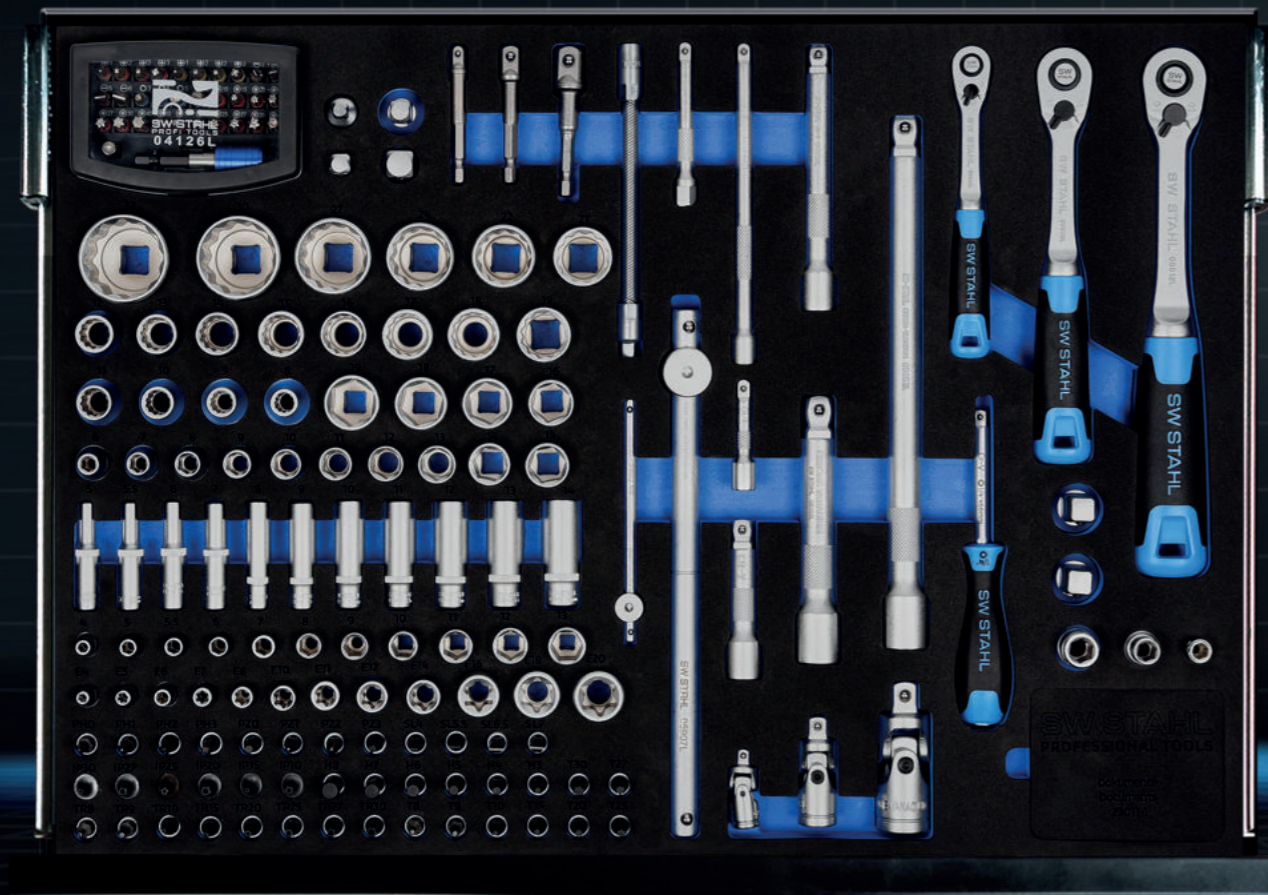

DESIGNED
IN GERMANY

THE TROLLEY INTERIOR

TT801



72

PIECE Z3011-11

WORKSHOP TROLLEY ASSORTMENT BIT-SOCKET

TOOLS

- Bit-sockets with hexagonal, short, 5 - 17 mm
- Bit-sockets with hexagonal, long, 5 - 17 mm
- Bit-sockets, splined, short, M5 - M14
- Bit-sockets, splined, long, M5 - M14
- Bit-sockets with T-Profil (Torx®), short, T20 - T55
- Bit-sockets with T-Profil (Torx®), long, T20 - T55
- T-handle socket spanner, hexagon, 8 - 13 mm
- Allen key set, hexagon, 2 - 10 mm
- Allen key set, T-Profil (Torx®), T10 - T50
- Allen key set, TR-Profil (Torx® tamper resistant), T10 - T50

INSERT

- SW-Stahl system foam insert, size 3/3
- For drawers with 570 x 400 mm
- 2-component soft foam insert
- Equipped with 72 tools
- Details see parts list

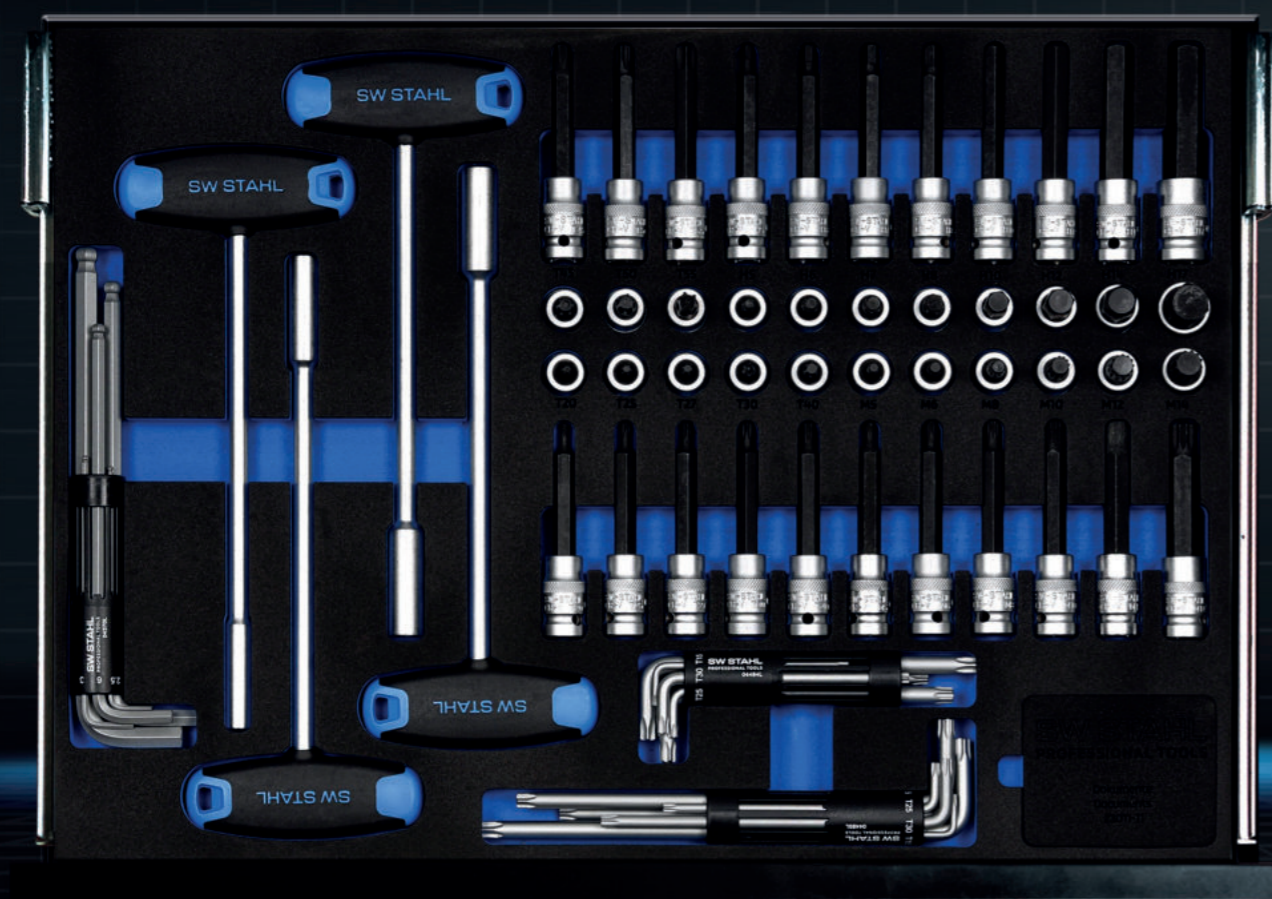

DESIGNED
IN GERMANY

THE TROLLEY INTERIOR

TT801



144

PIECE Z3011-14

WORKSHOP TROLLEY ASSORTMENT SOCKETS AND RATCHETS 1/4" + 3/8" + 1/2"

TOOLS

- Ratchet wrench, slim design
- Sliding handles
- Extensions
- Cardan joints
- Socket spanners with hex and double-hex, 4 - 32 mm
- Bit-sockets with hexagonal, 3 - 12 mm
- Bit-sockets, splined, M6 - M14
- Bit-sockets with T-Profil (Torx®), T8 - T50
- Bit-sockets with TR-Profil (Torx® tamper resistant), T10 - T30
- Bit-sockets with TPR-Profil (TorxPLUS® Security, 5-stars), IP10 - IP30
- Bit assortment with bit adapter
- Allen key set, hexagon, 2 - 10 mm
- Allen key set, T-Profil (Torx®), T10 - T50

INSERT

- SW-Stahl system foam insert, size 3/3
- For drawers with 570 x 400 mm
- 2-component soft foam insert
- Equipped with 144 tools
- Details see parts list



DESIGNED
IN GERMANY

THE TROLLEY INTERIOR

TT801



44

PIECE Z3011-15

WORKSHOP TROLLEY ASSORTMENT TOOL ASSORTMENT, COMBINATION SPANNERS AND GENERAL HAND TOOLS

TOOLS

- Combination spanners, 6 - 24 mm
- Double-ring spanners, cranked, 6 - 22 mm
- Double-ring spanners with E-Profil, E6 - E24
- T-handle socket spanner, hexagon, 8 und 10 mm
- Hammer, 500 gram
- Flat chisel
- Centre punch
- Punches, 2 - 8 mm
- Telescopic magnetic lifter

INSERT

- SW-Stahl system foam insert, size 3/3
- For drawers with 570 x 400 mm
- 2-component soft foam insert
- Equipped with 44 tools
- Details see parts list



THE TROLLEY INTERIOR

TT801



28

PIECE Z3011-9

WORKSHOP TROLLEY ASSORTMENT GENERAL HAND TOOLS

TOOLS

- Hammer, 500 gram
- Flat chisel
- Centre punch
- Punches, 2 - 10 mm
- Screwdrivers with flexible shaft
- Caliper, digital
- Tape measure, 5 m
- Valve gauge
- Telescopic magnetic lifter
- Workshop file, flat
- Brake caliper file
- Brake caliper brush
- Spark plug socket, double-hex, 14, 16, 21 mm
- Spark plug connector plier
- Wheel nut sockets, 17, 19, 21 mm

INSERT

- SW-Stahl system foam insert, size 3/3
 - For drawers with 570 x 400 mm
 - 2-component soft foam insert
 - Equipped with 28 tools
- Details see parts list

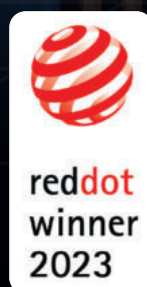

DESIGNED
IN GERMANY

THE TROLLEY INTERIOR

TT802



203

PIECE Z3011-3

WORKSHOP TROLLEY ASSORTMENT SOCKETS AND RATCHETS 1/4" + 3/8" + 1/2"

TOOLS

- Ratchet wrench, slim design
- Sliding handles
- Extensions
- Cardan joints
- Enlargement and reduction adapters
- Socket spanners with hex and double-hex, 4 - 32 mm
- Socket spanners with E-Profil, E4 - E20
- Bit-sockets with slot, 4 - 7 mm
- Bit-sockets with cross (PH und PZ), P0 - P3
- Bit-sockets with hexagonal, 3 - 17 mm
- Bit-sockets, splined, M5 - M12
- Bit-sockets with T-Profil (Torx®), T8 - T55
- Bit-sockets with TR-Profil (Torx® tamper resistant), T8 - T30
- Bit-sockets with TPR-Profil (TorxPLUS® Security, 5-stars), IP10 - IP30
- Bit assortment with bit adapter

INSERT

- SW-Stahl system foam insert, size 4/3
- For drawers with 760 x 400 mm
- 2-component soft foam insert
- Equipped with 203 tools
- Details see parts list

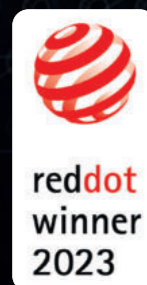
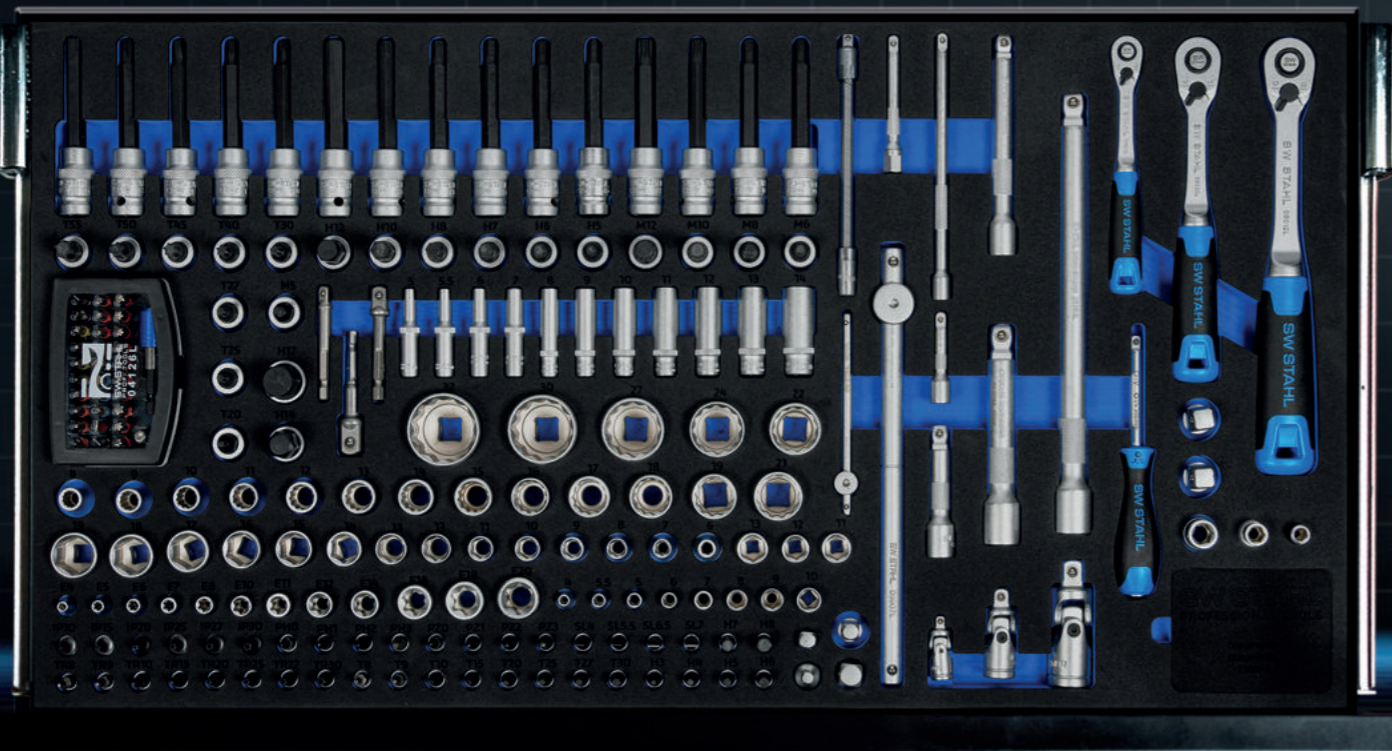

DESIGNED
IN GERMANY

THE TROLLEY INTERIOR

TT802



57

PIECE

Z3011-5



WORKSHOP TROLLEY ASSORTMENT COMBINATION AND RATCHET SPANNERS

TOOLS

- Combination spanners, 6 - 27 mm
- Double-ring spanners with E-Profil, E6 - E24
- Double-ring spanners, cranked, 6 - 32 mm
- Combination ratchet spanners, 8 - 19 mm
- Brake line spanners, 10 - 13 mm
- Adapter set for sockets and bits

INSERT

- SW-Stahl system foam insert, size 4/3
- For drawers with 760 x 400 mm
- 2-component soft foam insert
- Equipped with 57 tools
- Details see parts list



THE TROLLEY INTERIOR

TT802



44

PIECE Z3011-8

WORKSHOP TROLLEY ASSORTMENT SCREWDRIVERS AND PLIERS



TOOLS

- Screwdrivers, cross, PH0 - PH3
- Screwdrivers, slot, 2,0 - 6,5 mm
- Screwdrivers, T-Profil (Torx®), T6 - T30
- T-handle socket spanner, hexagon, 8 und 10 mm
- Allen key set, hexagon, 2 - 10 mm
- Allen key set, T-Profil (Torx®), T10 - T50
- Combination plier, 180 mm
- Side cutter, 180 mm
- Lever-force side-cutting plier, 200 mm
- Bent nose plier, 200 mm
- Long nose plier, 200 mm
- Rabitz plier, 220 mm
- Water pump plier, 240 mm

INSERT

- SW-Stahl system foam insert, size 4/3
- For drawers with 760 x 400 mm
- 2-component soft foam insert
- Equipped with 44 tools
- Details see parts list



DESIGNED
IN GERMANY

THE TROLLEY INTERIOR

TT802



34

PIECE Z3011-10

WORKSHOP TROLLEY ASSORTMENT GENERAL HAND TOOLS

TOOLS

- Hammer, 500 gram
- Flat chisel
- Centre punch
- Punches, 3 – 8 mm
- Screwdrivers with flexible shaft
- Caliper, digital
- Tape measure, 5 m
- Knife with break-off blades
- Valve gauge
- Telescopic magnetic lifter
- Workshop files
- Brake caliper file
- Brake caliper brush
- Spark plug socket, double-hex, 14, 16, 21 mm
- Spark plug connector plier
- Wheel nut sockets, 15, 17, 19, 21 mm
- Wheel nut sockets Mercedes and Kia
- Tyre depth gauge, digital
- LED low voltage circuit tester, 3 - 48 V

INSERT

- SW-Stahl system foam insert, size 4/3
- For drawers with 760 x 400 mm
- 2-component soft foam insert
- Equipped with 34 tools
- Details see parts list



DESIGNED
IN GERMANY

THE TROLLEY INTERIOR

TT802



95

PIECE

Z3011-12

WORKSHOP TROLLEY ASSORTMENT SOCKETS AND RATCHET 1/2"



TOOLS

- Ratchet wrench 1/2", high torque
- Jointed heavy-duty wrench, 1/2", 630 mm
- Extensions
- Cardan joint
- Socket spanners with double-hexagon, short, 8 - 36 mm
- Socket spanners with double-hexagon, long, 8 - 36 mm
- Bit-sockets with hexagonal, short, 4 - 17 mm
- Bit-sockets with hexagonal, long, 4 - 17 mm
- Bit-sockets, splined, short, M5 - M14
- Bit-sockets, splined, long, M5 - M14
- Bit-sockets with T-Profil (Torx®), short, T20 - T60
- Bit-sockets with T-Profil (Torx®), long, T20 - T60

INSERT

- SW-Stahl system foam insert, size 4/3
- For drawers with 760 x 400 mm
- 2-component soft foam insert
- Equipped with 95 tools
- Details see parts list

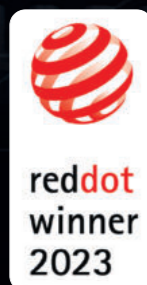

DESIGNED
IN GERMANY

THE TROLLEY INTERIOR

TT802

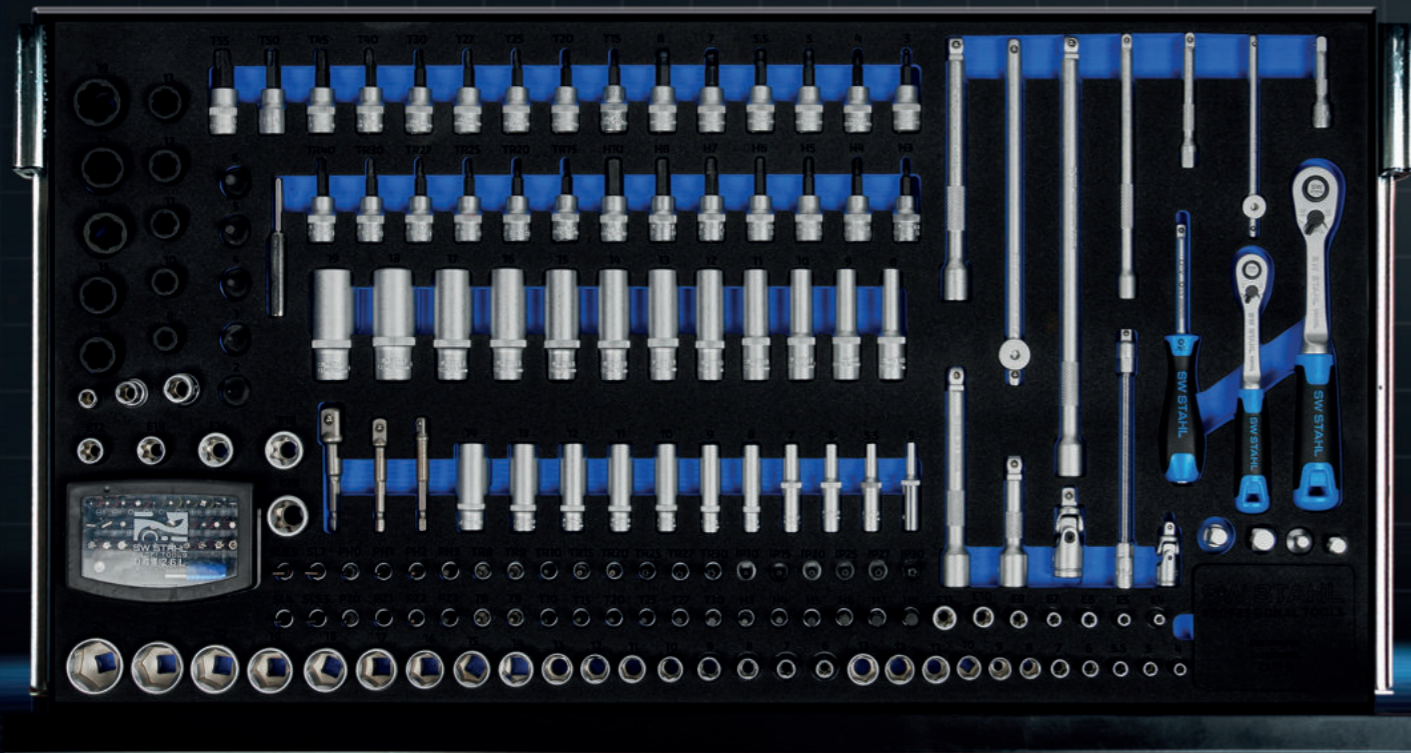

204

PIECE Z3011-13

WORKSHOP TROLLEY ASSORTMENT SOCKETS AND RATCHETS 1/4" + 3/8"

TOOLS

- Ratchet wrenches, high torque
- Sliding handles
- Extensions
- Cardan joints
- Enlargement and reduction adapters
- Socket spanners with Sechskant-Abtrieb, 4 - 24 mm
- Socket spanners with E-Profil, E4 - E20
- Socket spanners with helical groove
- Bit-sockets with slot, 4 - 7 mm
- Bit-sockets with cross (PH und PZ), P0 - P3
- Bit-sockets with hexagonal, 3 - 10 mm
- Bit-sockets with T-Profil (Torx®), T8 - T55
- Bit-sockets with TR-Profil (Torx® tamper resistant), T8 - T40
- Bit-sockets with TPR-Profil (TorxPLUS® Security, 5-stars), IP10 - IP30
- Bit assortment with bit adapter

INSERT

- SW-Stahl system foam insert, size 4/3
- For drawers with 760 x 400 mm
- 2-component soft foam insert
- Equipped with 204 tools
- Details see parts list



DESIGNED
IN GERMANY

ACCESSORIES

AS INDIVIDUAL AS YOU.

TT801 TT802



THE TROLLEY
ACCESSORIES

**ALL
DATA
AT A
GLANCE!**



LAPTOP HOLDER

Suitable for all common laptops and tablets. This holder can be adjusted along all axes, enabling it to be locked in practical positions.

TT801

TT802

THE TROLLEY ACCESSORIES



SPRAY CAN HOLDER

Holds up to 3 spray cans.
The holder can be hung in the side
grid holes.

TT801 TT802

THE SIDE HOLDS EVERYTHING.



PAPER ROLL HOLDER

Suitable for paper rolls with a maximum
diameter of 300 mm and a width of 300 mm



THE TROLLEY ACCESSORIES



DRAWER DIVIDER SET

11-piece: If no foam inserts are used, these drawer dividers are a must for every workshop trolley.



PAPER BIN

Everything disposed of immediately. The right waste paper bin ensures order in the workplace.

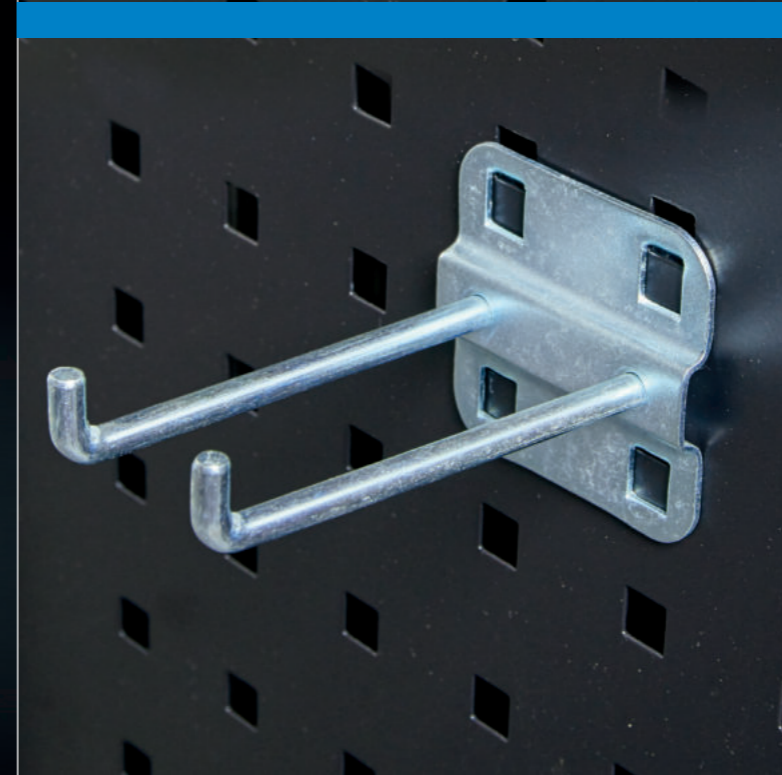

HOOK SETS

This allows the workshop trolley to be individually equipped with different tools.

TT801 TT802





TT801

TT802

SETS

SW STAHL
PROFESSIONAL TOOLS

THE TROLLEY SETS

TT801
BLUE
Z3110

341
PIECE



TOOL ASSORTMENT GENERAL HAND TOOLS
28-PIECE

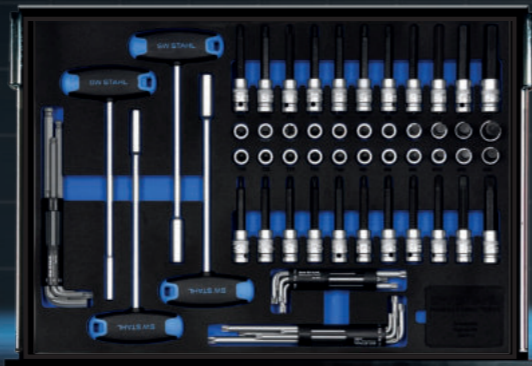

TOOL ASSORTMENT SOCKETS
72-PIECE

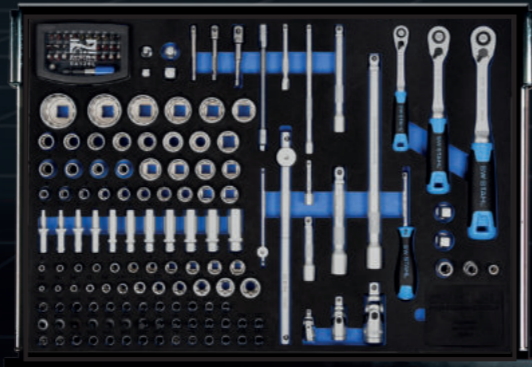

TOOL ASSORTMENT SOCKETS 1/4", 3/8", 1/2"
167-PIECE



TOOL ASSORTMENT COMBINATION AND RATCHET SPANNERS
49-PIECE



TOOL ASSORTMENT SCREWDRIVERS AND PLIERS
25-PIECE

TT801
BLACK
Z3111

341
PIECE



TOOL ASSORTMENT GENERAL HAND TOOLS
28-PIECE

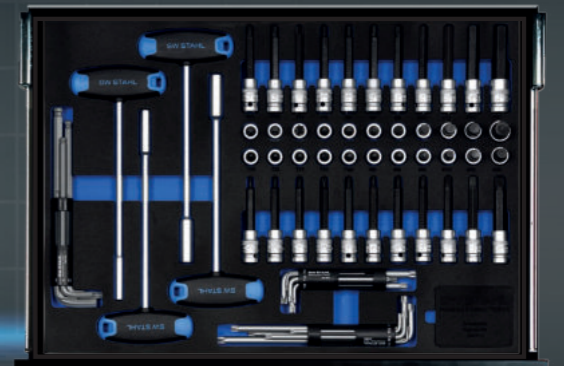

TOOL ASSORTMENT SOCKETS
72-PIECE



TOOL ASSORTMENT SOCKETS 1/4", 3/8", 1/2"
167-PIECE



TOOL ASSORTMENT COMBINATION AND RATCHET SPANNERS
49-PIECE



TOOL ASSORTMENT SCREWDRIVERS AND PLIERS
25-PIECE

THE TROLLEY SETS

TT801
BLUE
Z3113

246
PIECE



TOOL ASSORTMENT GENERAL HAND TOOLS
28-PIECE

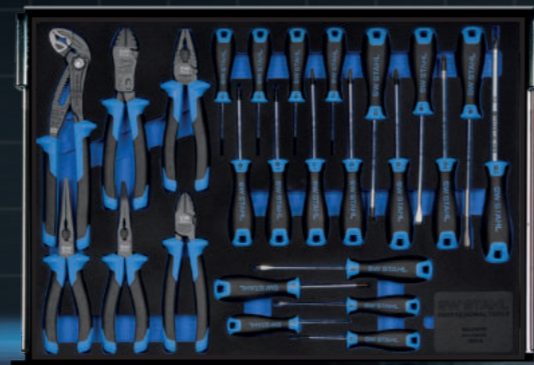

TOOL ASSORTMENT SCREWDRIVERS AND PLIERS
25-PIECE



TOOL ASSORTMENT COMBINATION AND RATCHET SPANNERS
49-PIECE



TOOL ASSORTMENT SOCKETS
144-PIECE



TT801
BLACK
Z3114

246
PIECE



TOOL ASSORTMENT GENERAL HAND TOOLS
28-PIECE



TOOL ASSORTMENT SCREWDRIVERS AND PLIERS
25-PIECE



TOOL ASSORTMENT COMBINATION AND RATCHET SPANNERS
49-PIECE



TOOL ASSORTMENT SOCKETS
144-PIECE

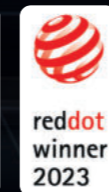

THE TROLLEY SETS

TT801
BLUE
Z3116

213
PIECE

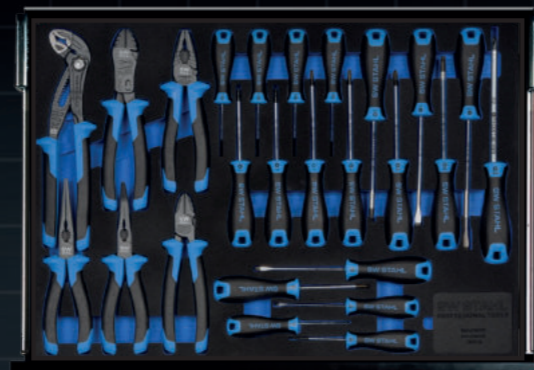

TOOL ASSORTMENT SCREWDRIVERS AND PLIERS
25-PIECE



TOOL ASSORTMENT SOCKETS
144-PIECE



TOOL ASSORTMENT COMBINATION AND RATCHET SPANNERS
44-PIECE



TT801
BLACK
Z3117

213
PIECE

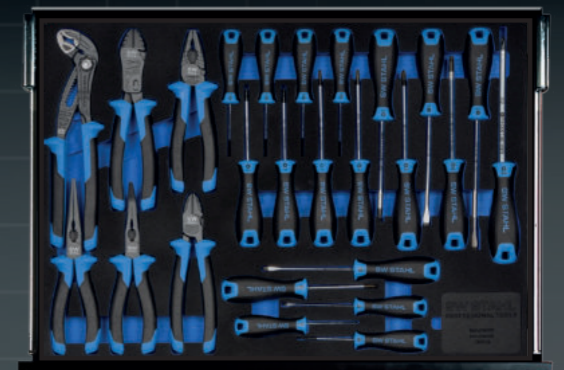

TOOL ASSORTMENT SCREWDRIVERS AND PLIERS
25-PIECE

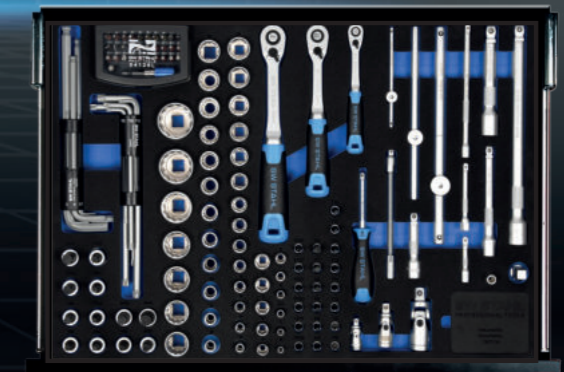

TOOL ASSORTMENT SOCKETS
144-PIECE



TOOL ASSORTMENT COMBINATION AND RATCHET SPANNERS
44-PIECE



THE TROLLEY SETS

TT802
BLUE
Z3200

434
PIECE

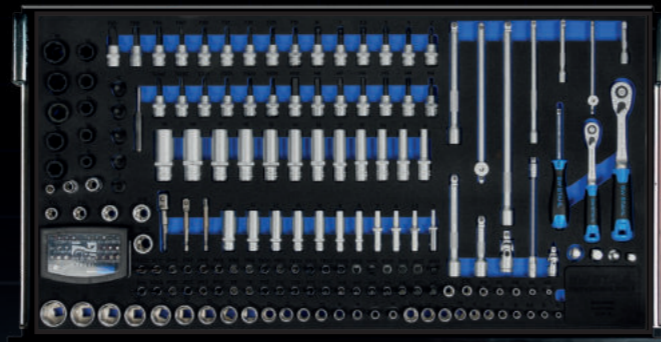

TOOL ASSORTMENT SOCKETS 1/4", 3/8"
204-PIECE



TOOL ASSORTMENT COMBINATION AND RATCHET SPANNERS
57-PIECE



TOOL ASSORTMENT SCREWDRIVERS AND PLIERS
44-PIECE



TOOL ASSORTMENT SOCKETS 1/2"
95-PIECE



TOOL ASSORTMENT GENERAL HAND TOOLS
34-PIECE



TT802
BLACK
Z3201

434
PIECE

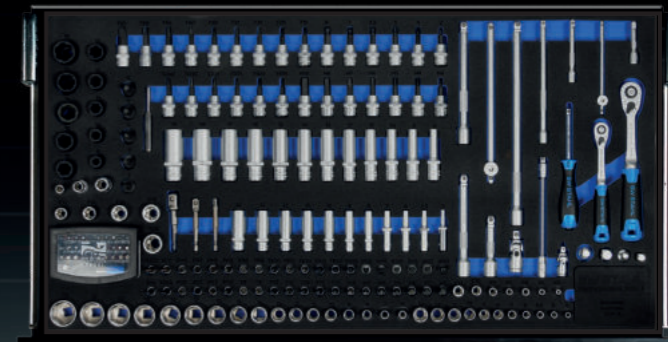

TOOL ASSORTMENT SOCKETS 1/4", 3/8"
204-PIECE



TOOL ASSORTMENT COMBINATION AND RATCHET SPANNERS
57-PIECE



TOOL ASSORTMENT SCREWDRIVERS AND PLIERS
44-PIECE



TOOL ASSORTMENT SOCKETS 1/2"
95-PIECE



TOOL ASSORTMENT GENERAL HAND TOOLS
34-PIECE

THE TROLLEY SETS

TT802
BLUE
Z3211

338
PIECE

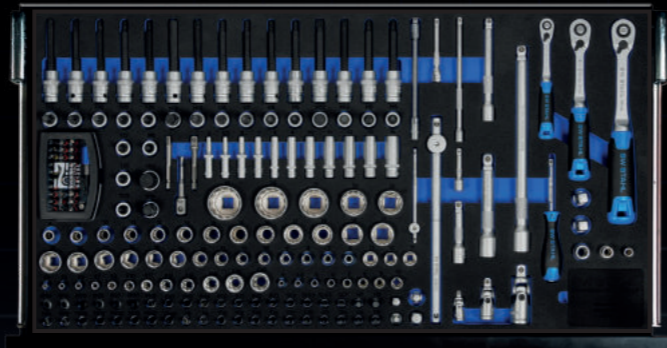

TOOL ASSORTMENT SOCKETS 1/4", 3/8", 1/2"
203-PIECE



TOOL ASSORTMENT COMBINATION AND RATCHET SPANNERS
57-PIECE



TOOL ASSORTMENT SCREWDRIVERS AND PLIERS
44-PIECE



TOOL ASSORTMENT GENERAL HAND TOOLS
34-PIECE



TT802
BLACK
Z3212

338
PIECE

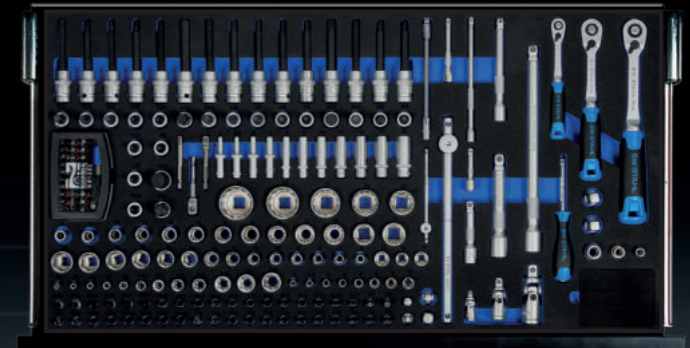

TOOL ASSORTMENT SOCKETS 1/4", 3/8", 1/2"
203-PIECE



TOOL ASSORTMENT COMBINATION AND RATCHET SPANNERS
57-PIECE



TOOL ASSORTMENT SCREWDRIVERS AND PLIERS
44-PIECE



TOOL ASSORTMENT GENERAL HAND TOOLS
34-PIECE



THE TROLLEY SETS

TT802
BLUE
Z3208

304
PIECE

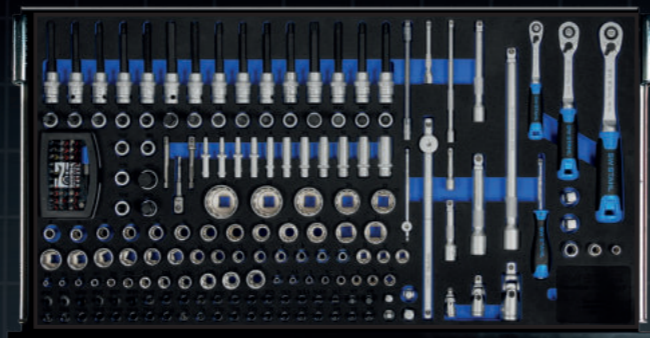

TOOL ASSORTMENT SOCKETS 1/4", 3/8", 1/2"
203-PIECE



TOOL ASSORTMENT COMBINATION AND RATCHET SPANNERS
57-PIECE



TOOL ASSORTMENT SCREWDRIVERS AND PLIERS
44-PIECE



TT802
BLACK
Z3209

304
PIECE

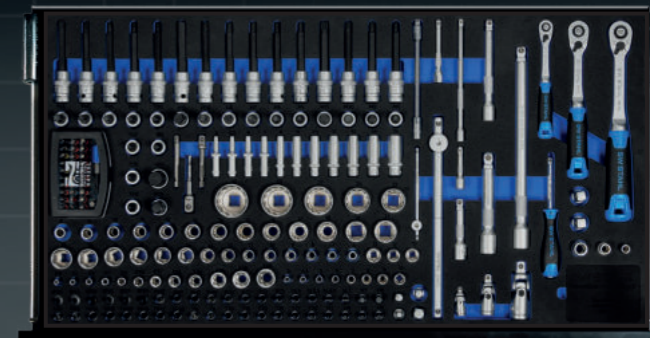

TOOL ASSORTMENT SOCKETS 1/4", 3/8", 1/2"
203-PIECE



TOOL ASSORTMENT COMBINATION AND RATCHET SPANNERS
57-PIECE



TOOL ASSORTMENT SCREWDRIVERS AND PLIERS
44-PIECE



EVERYTHING AT A GLANCE!



THE TROLLEY

AT A GLANCE

THE INTERIOR

TT801

WORKSHOP TROLLEY ASSORTMENT
SCREWDRIVERS
AND PLIERS



25-PIECE

ARTICLE NUMBER

Z3011-6

TT801

WORKSHOP TROLLEY ASSORTMENT
SOCKETS UND
WINKELSCHLÜSSEL

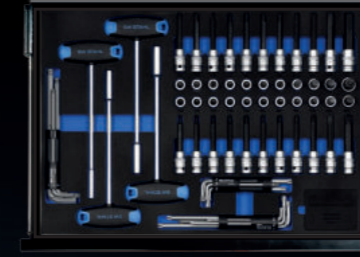

72-PIECE

ARTICLE NUMBER

Z3011-11

TT801

WORKSHOP TROLLEY ASSORTMENT
SOCKETS
1/4" + 3/8" + 1/2"

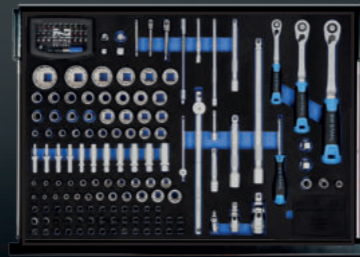

167-PIECE

ARTICLE NUMBER

Z3011-1

TT801

WORKSHOP TROLLEY ASSORTMENT
SOCKETS
1/4" + 3/8" + 1/2"

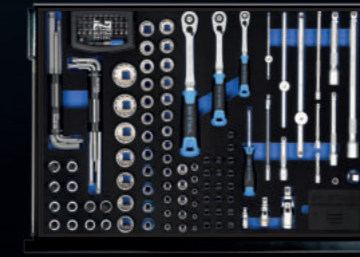

144-PIECE

ARTICLE NUMBER

Z3011-14

TT801

WORKSHOP TROLLEY ASSORTMENT
COMBINATION AND
RATCHET SPANNERS



49-PIECE

ARTICLE NUMBER

Z3011-4

TT801

WORKSHOP TROLLEY ASSORTMENT
GENERAL
HAND TOOLS



44-PIECE

ARTICLE NUMBER

Z3011-15

TT801

WORKSHOP TROLLEY ASSORTMENT
GENERAL
HAND TOOLS



28-PIECE

ARTICLE NUMBER

Z3011-9

THE TROLLEY

AT A GLANCE

THE INTERIOR

TT802

WORKSHOP TROLLEY ASSORTMENT
SOCKETS
1/4" + 3/8"

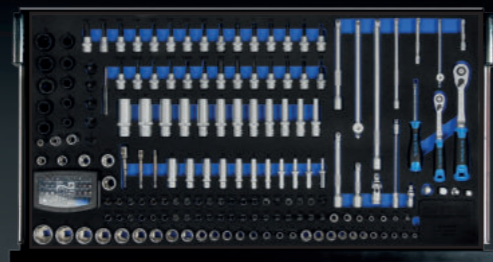

204-PIECE

ARTICLE NUMBER

Z3011-13

TT802

WORKSHOP TROLLEY ASSORTMENT
GENERAL
HAND TOOLS



34-PIECE

ARTICLE NUMBER

Z3011-10

TT802

WORKSHOP TROLLEY ASSORTMENT
COMBINATION AND
RATCHET SPANNERS

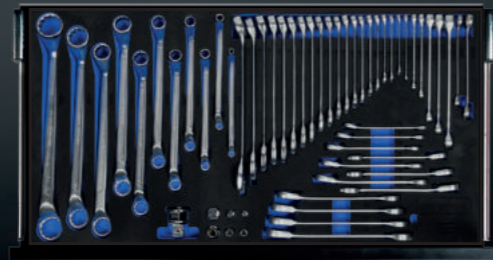

57-PIECE

ARTICLE NUMBER

Z3011-5

TT802

WORKSHOP TROLLEY ASSORTMENT
SOCKETS
1/4" + 3/8" + 1/2"

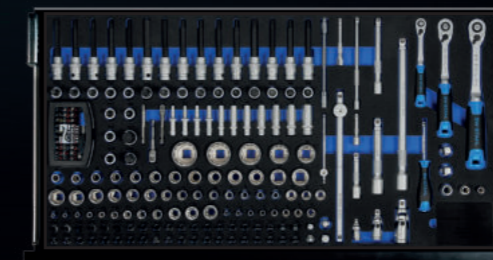

203-PIECE

ARTICLE NUMBER

Z3011-3

TT802

WORKSHOP TROLLEY ASSORTMENT
SOCKETS
1/2"



95-PIECE

ARTICLE NUMBER

Z3011-12

TT802

WORKSHOP TROLLEY ASSORTMENT
SCREWDRIVERS
AND PLIERS



44-PIECE

ARTICLE NUMBER

Z3011-8

THE TROLLEY

AT A GLANCE

THE ACCESSORIES

LAPTOP HOLDER



ARTICLE NUMBER

07124L

SPRAY CAN
HOLDER



ARTICLE NUMBER

07120L

PAPER ROLL
HOLDER

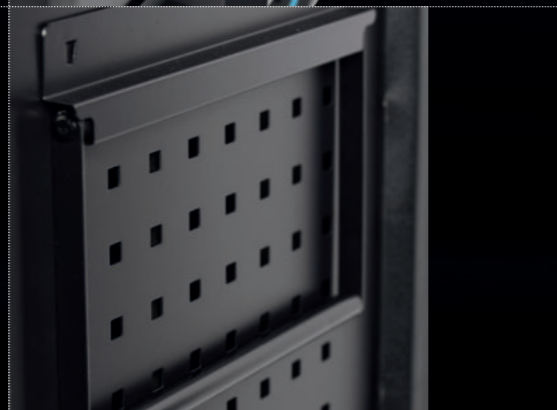

ARTICLE NUMBER

07121L

DRAWER DIVIDER
SET



ARTICLE NUMBER

07123L

SINGLE HOOK SET
5 PIECES:

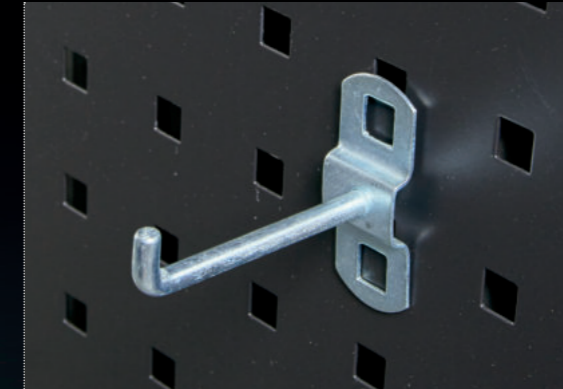

ARTICLE NUMBER

07051L

DOUBLE HOOK SET
5 PIECES:

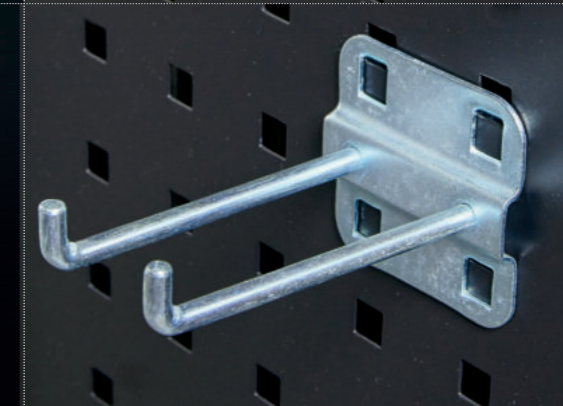

ARTICLE NUMBER

07052L

PAPER BIN



ARTICLE NUMBER

07122L

THE TROLLEY

AT A GLANCE

THE SETS

TT801
BLUE



341-PIECE

ARTICLE NUMBER

Z3110



TT801
BLUE



246-PIECE

ARTICLE NUMBER

Z3113



TT801
BLACK



341-PIECE

ARTICLE NUMBER

Z3111



TT801
BLACK



246-PIECE

ARTICLE NUMBER

Z3114



THE TROLLEY

AT A GLANCE

THE SETS

TT801
BLUE



213-PIECE

ARTICLE NUMBER

Z3116



TT802
BLUE



434-PIECE

ARTICLE NUMBER

Z3200



TT801
BLACK



213-PIECE

ARTICLE NUMBER

Z3117



TT802
BLACK



434-PIECE

ARTICLE NUMBER

Z3201



THE TROLLEY

AT A GLANCE

THE SETS

TT802
BLUE



338-PIECE

ARTICLE NUMBER

Z3211



TT802
BLUE



304-PIECE

ARTICLE NUMBER

Z3208



TT802
BLACK

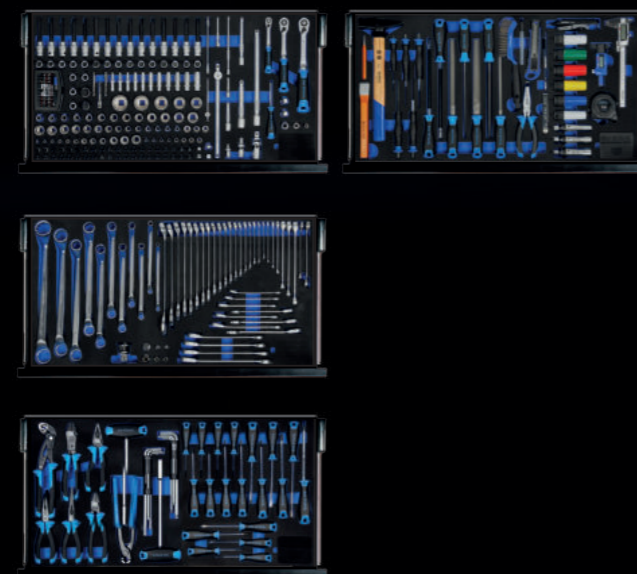

338-PIECE

ARTICLE NUMBER

Z3212



TT802
BLACK

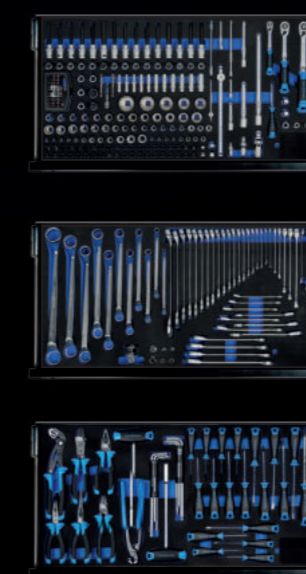

304-PIECE

ARTICLE NUMBER

Z3209



ONE YEAR WARRANTY EXTENSION FOR FREE!

Simply register after purchasing a TT workshop trolley model on our **PROFESSIONAL TOOLS PORTAL**.

Upload proof of purchase, and the warranty on your new workshop trolley will be extended from 2 years to 3 years.

IT DOESN'T GET ANY BETTER!



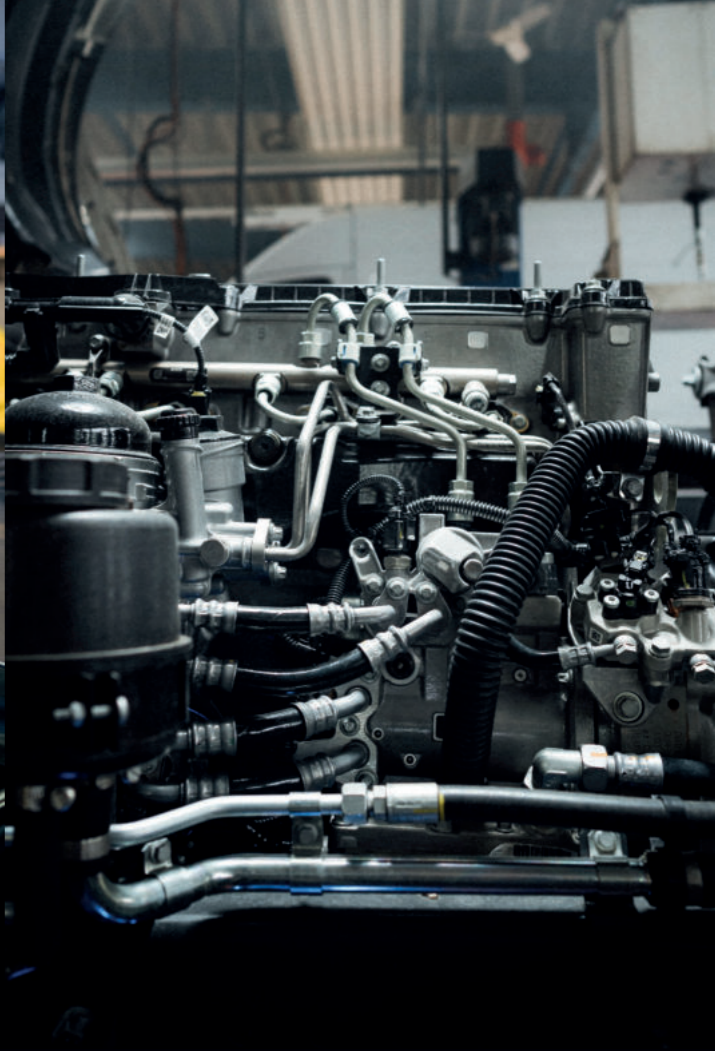
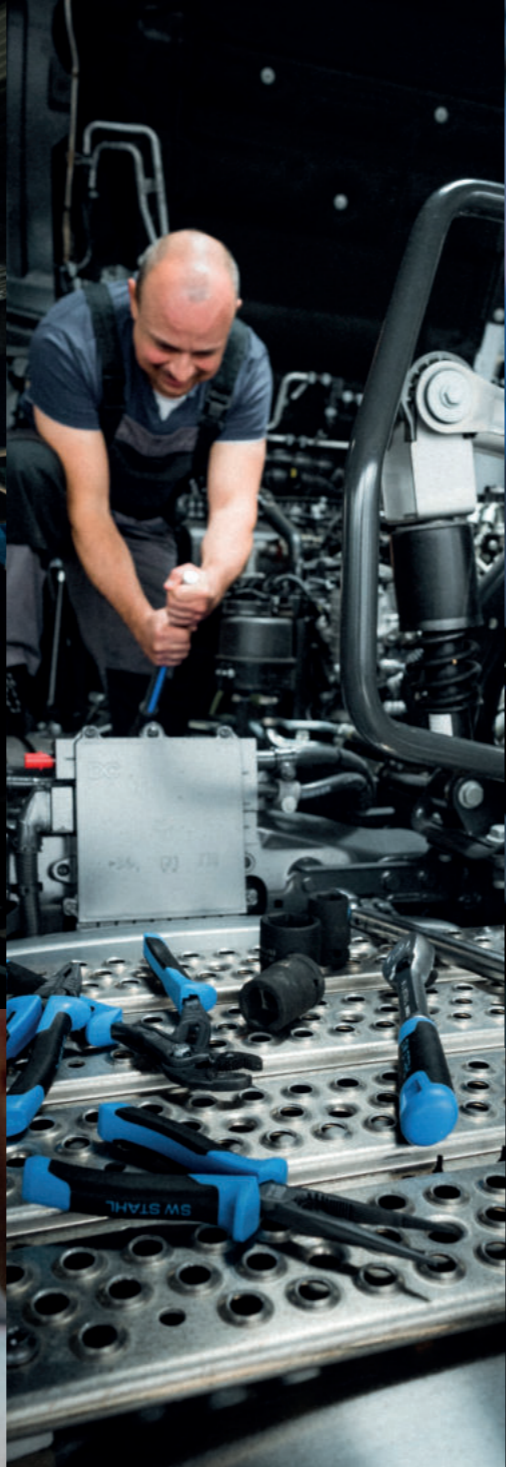

BEHIND THE SCENES



SW STAHL
TOOL TROLLEY
FILM



TT 801



TT 802



PROFESSIONAL TOOLS
SW STAHL

PROFESSIONAL TOOLS
SW STAHL



SW STAHL IMAGEFILM



SW STAHL
PROFESSIONAL TOOLS